

SF5000. 3/8

"F" FLEXIBLE Series
Solenoid / Pneumatic Valves

- 5/2, 5/3, 3/2 - 3/8
- 32mm Body Width
- Transition Flow 2000ℓ/min (5bar)

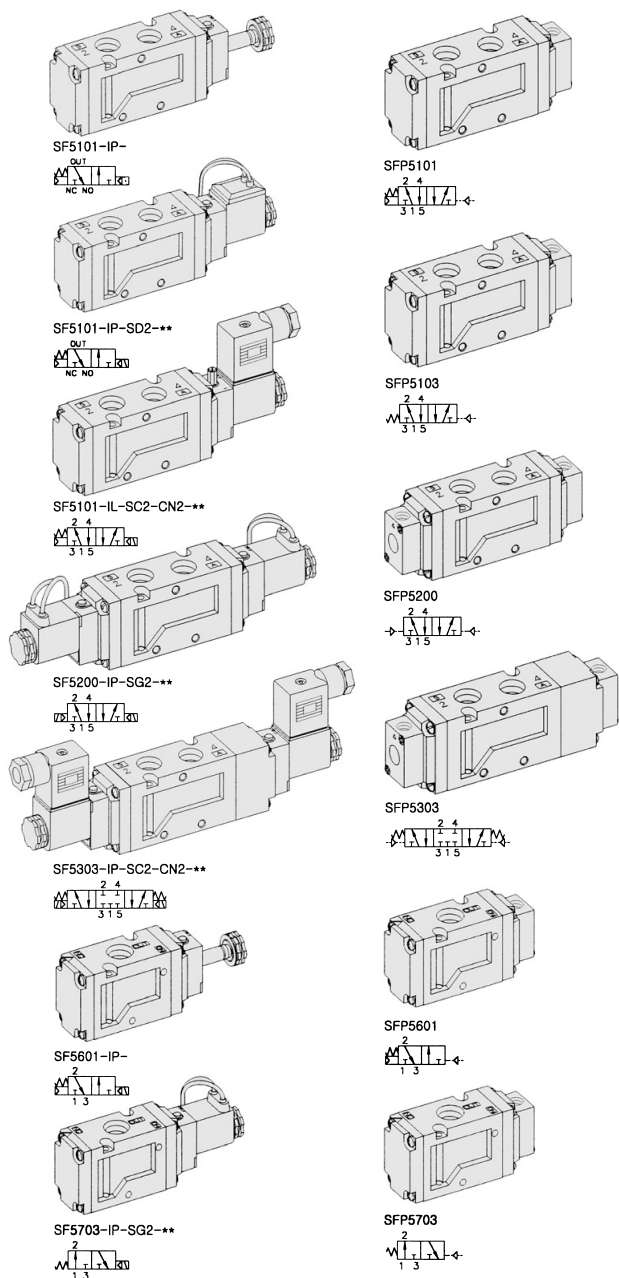

** : Voltage Selection (see page 62)

SPECIFICATION

ITEM	SERIES	SOLENOID, PNEUMATIC	
		FUNCTION	
		5, 3 Port 2 Position	5 Port 3 Position
Fluids		Compressed Air & Inert Gases	
Pressure(bar)		1.5~10.0	2.0~10.0
Eff. Sectional Area(mm ²)-5bar		36.0	30.0
Ambient & Fluid Temp.		5~60°C(41~140°F)	
Response Time(5bar)		30ms or Less	40ms or Less
Max. Working Frequency		5c/sec	3c/sec
Lubrication		Not Required(Use ISO VG32 #)	
Manual Override		Push Button(Standard), Lever Lock(Option)	
Coil Insulation Class		F-Class or Equivalent	
Permissible Voltage Variation		±10% of Rated Voltage	
Off Min. Residual Voltage		AC:20% or Less / DC:10% or Less	
Power Consumption		Holding-AC:5.5VA(60Hz) / DC:2.5W	

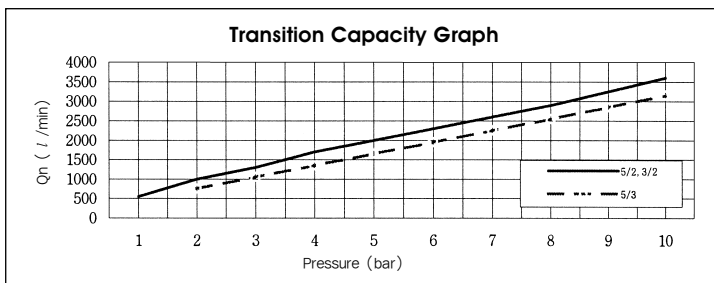

The Material of Parts

■ Valve Body : Die-Cast Aluminium	■ Pilot Parts : Glass Filled Nylon
■ Spool : Aluminium	■ Armature : Stainless Steel
■ Seals : NBR	■ Armature Seals : Viton
■ Spring : Stainless	
■ Cap : Zinc Pressure Die-Cast	

* The specification on each item can be amended without any prenotice to improve a performance.
* The specification on each item can be different from actual specification.

ORDERING NO.

SF5 1 0 1 - I P - SC2 - CN2 - A2

Valve Series	Function	Port Size & Thread	Return Method	Int/Ext. Pilot	Manual Operator	Solenoid Coil Type	Connector Type	Voltage
SF5 : Solenoid Valve	1 5/2 Single	0 G 3/8	0 None	1 Internal Pilot	0 None	0 None	0 None	0 None
	2 5/2 Double	1 NPT 3/8	1 Air + Spring		P Push Non-Locking	SC2 3 Pin Connector Coil	CN2 Normal Connector	A2 AC 220V
	3 5/3 Closed Center		2 Air		L Lever Locking	SG2 Grommet/Flying Leads	CD2 Connector With LED	A1 AC 110V
	4 5/3 Open Center		3 Spring			CZ2 Connector With LED & Surge Suppressor	A4 AC 24V	A4 AC 24V
SFP5 : Pneumatic Valve	5 5/3 Pressure Center					SD2 Grommet/Flying Leads With LED	D4 DC 24V	D4 DC 24V
	6 3/2 Normally Closed						D2 DC 12V	D2 DC 12V
	7 3/2 Normally Open							



Solenoid & Pilot Actuated Spool Valves

Port Thread 3/8

5Port 2Position Solenoid Valve

Single Solenoid
SF5101-IP-SC2-CN2-***

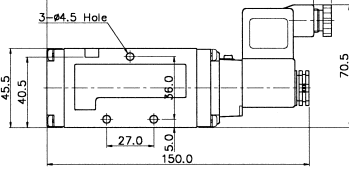
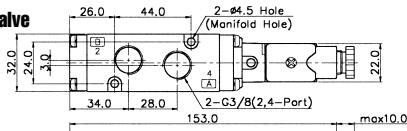

Double Solenoid
SF5200-IP-SC2-CN2-***

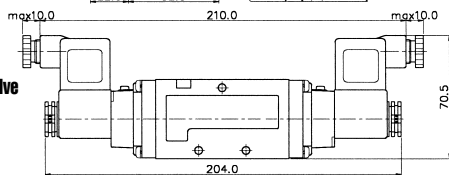

5Port 3Position Solenoid Valve

Closed Center
SF5303-IP-SC2-CN2-***

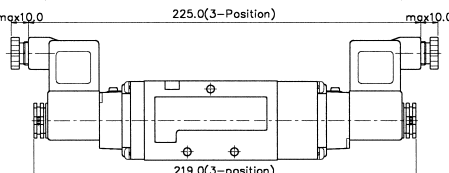

Exhaust Center
SF5403-IP-SC2-CN2-***



Pressure Center
SF5503-IP-SC2-CN2-***



3Port 2Position Solenoid Valve

Normally Closed
SF5601-IP-SD2-***

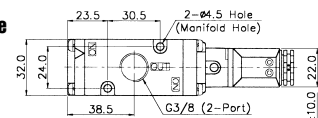

Normally Closed
SF5701-IP-SD2-***

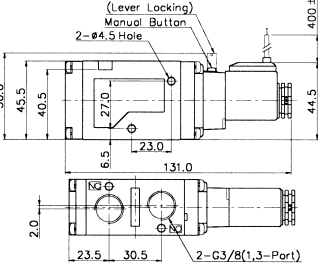

5Port 2Position Pneumatic Valve

Single Pneumatic
SFP5101

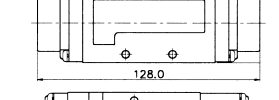
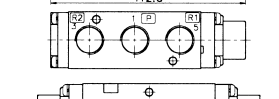
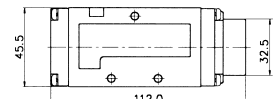
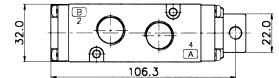

5Port 3Position Pneumatic Valve

Closed Center
SFP5303



Exhaust Center
SFP5403



Pressure Center
SFP5503



3Port 2Position Pneumatic Valve

Normally Closed
SFP5601

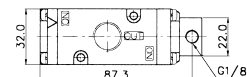

Normally Open
SFP5701

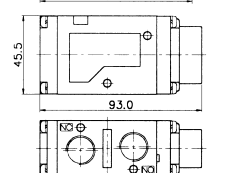

MF5000 MANIFOLD BLOCK

(SF5000 Solenoid & Pneumatic Valve Use)

Manifold Block Ordering Code

MF 5500		-		2	
Series	Manifold Station				
MF5500	5 Way	02	2-Station		
MF5300	3 Way	04	4-Station		
		06	6-Station		
		08	8-Station		
		10	10-Station		

Blanking Plate Ordering Code

MF5500-BLK	Blanking Plate (Material:SCP1)
	Manifold Gasket (Material:NBR)

MF5300-BLK	Blanking Plate (Material:SCP1)
	Manifold Gasket (Material:NBR)

5-Port Manifold Block

MF5500-4

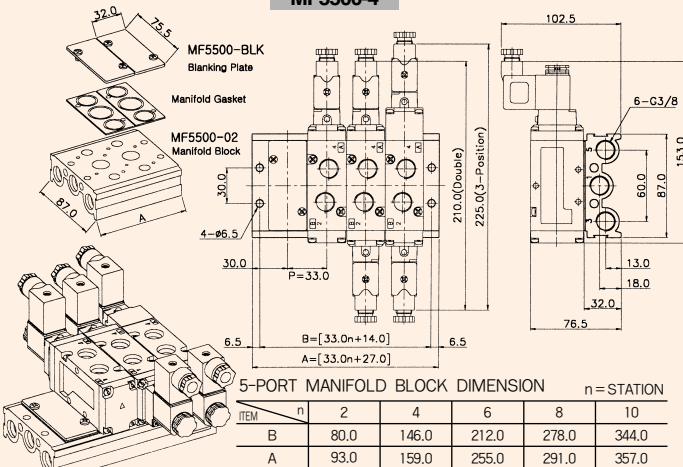

5-PORT MANIFOLD BLOCK DIMENSION		n = STATION				
ITEM	n	2	4	6	8	10
B		80.0	146.0	212.0	278.0	344.0
A		93.0	159.0	255.0	291.0	357.0

3-Port Manifold Block

MF5300-4

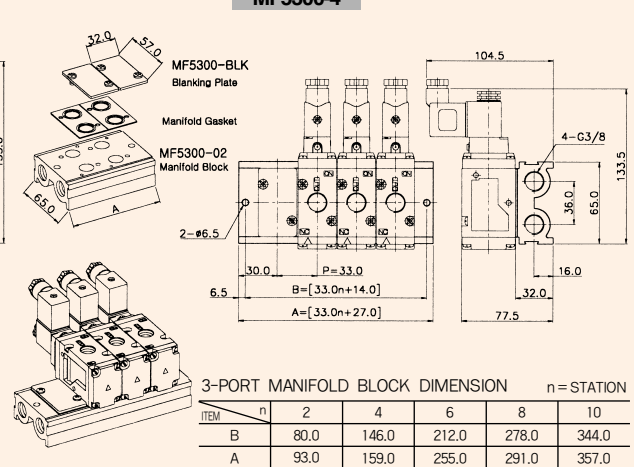

3-PORT MANIFOLD BLOCK DIMENSION		n = STATION				
ITEM	n	2	4	6	8	10
B		80.0	146.0	212.0	278.0	344.0
A		93.0	159.0	255.0	291.0	357.0