

SF3000. 1/8

"F" FLEXIBLE Series
Solenoid / Pneumatic Valves

- 5/2, 5/3 - 1/8
- 23mm Body Width
- Transition Flow 760ℓ/min (5bar)

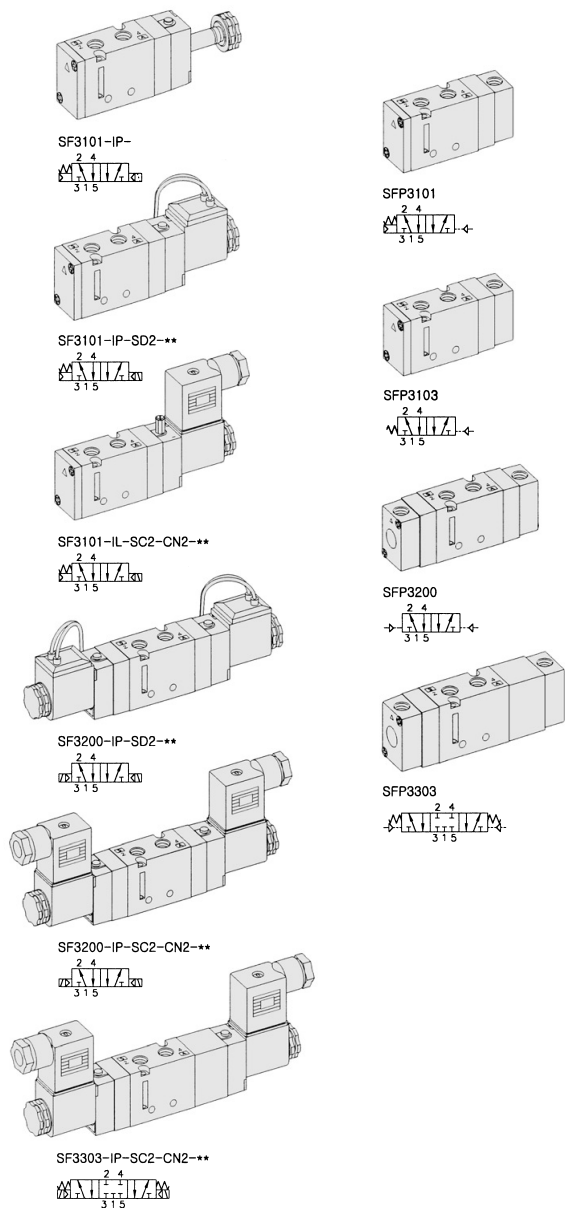

***: Voltage Selection (see page 62)

SPECIFICATION

ITEM	SERIES	SOLENOID, PNEUMATIC	
		5 Port 2 Position	5 Port 3 Position
Fluids		Compressed Air & Inert Gases	
Pressure(bar)		1.5~10.0	2.0~10.0
Eff. Sectional Area(mm ²)-5bar		13.5	11.0
Ambient & Fluid Temp.		5~60°C (41~140°F)	
Response Time(5bar)		25ms or Less	35ms or Less
Max. Working Frequency		5c/sec	3c/sec
Lubrication		Not Required(Use ISO VG32 #)	
Manual Override		Push Button(Standard), Lever Lock(Option)	
Coil Insulation Class		F-Class or Equivalent	
Permissible Voltage Variation		±10% of Rated Voltage	
Off Min. Residual Voltage		AC:20% or Less / DC:10% or Less	
Power Consumption		Holding-AC:5.5VA(60Hz) / DC:2.5W	

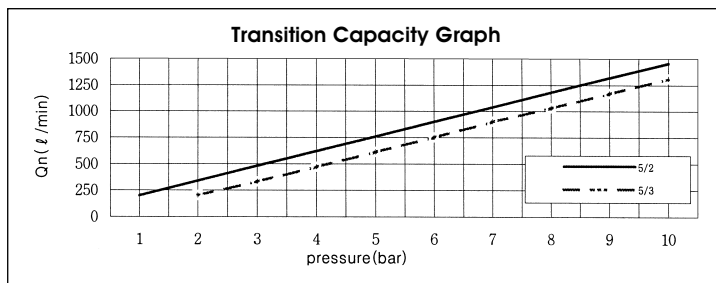

The Material of Parts

- Valve Body : Die-Cast Aluminium
- Spool : Aluminium
- Seals : NBR
- Spring : Stainless
- Cap : Zinc Pressure Die-Cast
- Pilot Parts : Glass Filled Nylon
- Armature : Stainless Steel
- Armature Seals : Viton

※ The specification on each item can be amended without any prenotice to improve a performance.
※ The specification on each item can be different from actual specification.

ORDERING NO.

SF3 1 0 1 - I P - SC2 - CN2 - A2

Valve Series	Function	Port Size & Thread	Return Method	Int/Ext. Pilot	Manual Operator	Solenoid Coil Type	Connector Type	Voltage
SF3 : Solenoid Valve	1 5/2 Single	0 G 1/8	0 None	1 Internal Pilot	0 None	0 None	0 None	0 None
	2 5/2 Double	1 NPT 1/8	1 Air + Spring		P Push	SC2 3 Pin Connector Coil	CN2 Normal Connector	A2 AC 220V
	3 5/3 Closed Center		2 Air		Non-Locking	SG2 Grommet/Flying Leads	CD2 Connector With LED	A1 AC 110V
	4 5/3 Open Center		3 Spring		L Lever Locking	SD2 Grommet/Flying Leads With LED	CZ2 Connector With LED & Surge Suppressor	A4 AC 24V D4 DC 24V D2 DC 12V
SFP3 : Pneumatic Valve	5 5/3 Pressure Center							

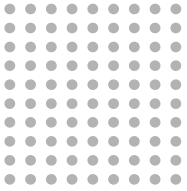

Solenoid & Pilot Actuated Spool Valves

Port Thread 1/8

5Port 2Position Solenoid Valve

Single Solenoid
SF3101-IP-SD2-***

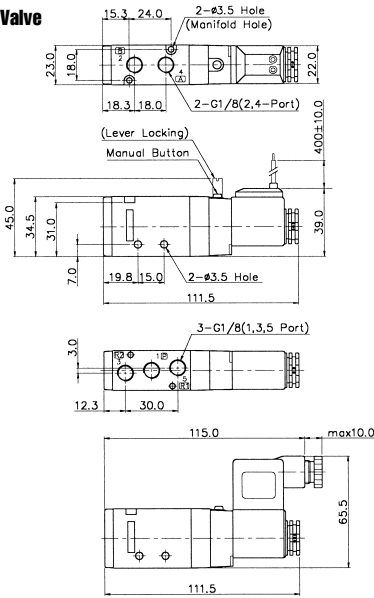

Double Solenoid
SF3200-IP-SC2-CN2-***

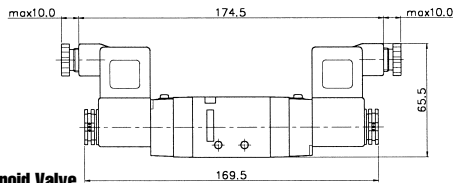

5Port 3Position Solenoid Valve

Closed Center
SF3303-IP-SC2-CN2-***

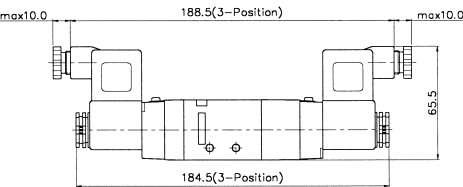
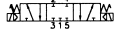

Exhaust Center
SF3403-IP-SC2-CN2-***

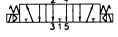

Pressure Center
SF3503-IP-SC2-CN2-***

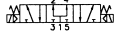

5Port 2Position Pneumatic Valve

Single Pneumatic
SFP3101

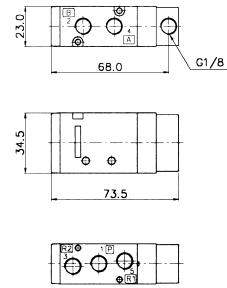
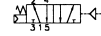

Double Pneumatic
SFP3200

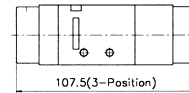
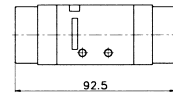
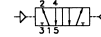

5Port 3Position Pneumatic Valve

Closed Center
SFP3303

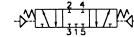

Exhaust Center
SFP3403

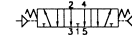

Pressure Center
SFP3503

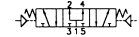

MF3000 MANIFOLD BLOCK

(SF3000 Solenoid & Pneumatic Valve Use)

5-Port Manifold Block

MF3500-4

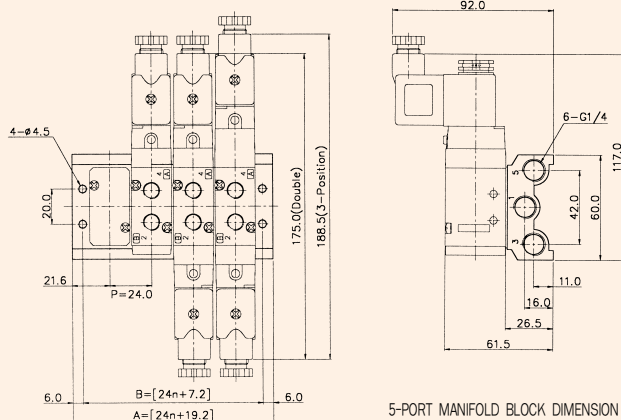
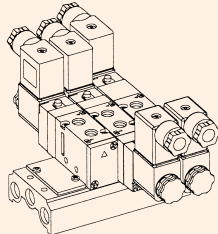
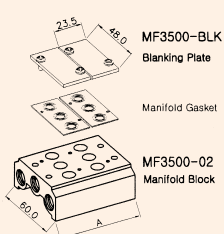

5-PORT MANIFOLD BLOCK DIMENSION n = STATION

ITEM	n	2	4	6	8	10
B		55.2	103.2	151.2	199.2	247.2
A		67.2	115.2	163.2	211.2	259.2

Manifold Block Ordering Code

MF 3500		-	2	
Series	Manifold Station			
MF3500	5 Way	02	2-Station	
		04	4-Station	
		06	6-Station	
		08	8-Station	
		10	10-Station	

Blanking Plate Ordering Code

MF3500-BLK	Blanking Plate. (Material: SCP1)
	Manifold Gasket. (Material: NBR)