

SF2000. 1/8

"F" FLEXIBLE Series
Solenoid / Pneumatic Valves

- 5/2, 5/3, 3/2 - 1/8
- 18mm Body Width
- Transition Flow 700ℓ/min (5bar)

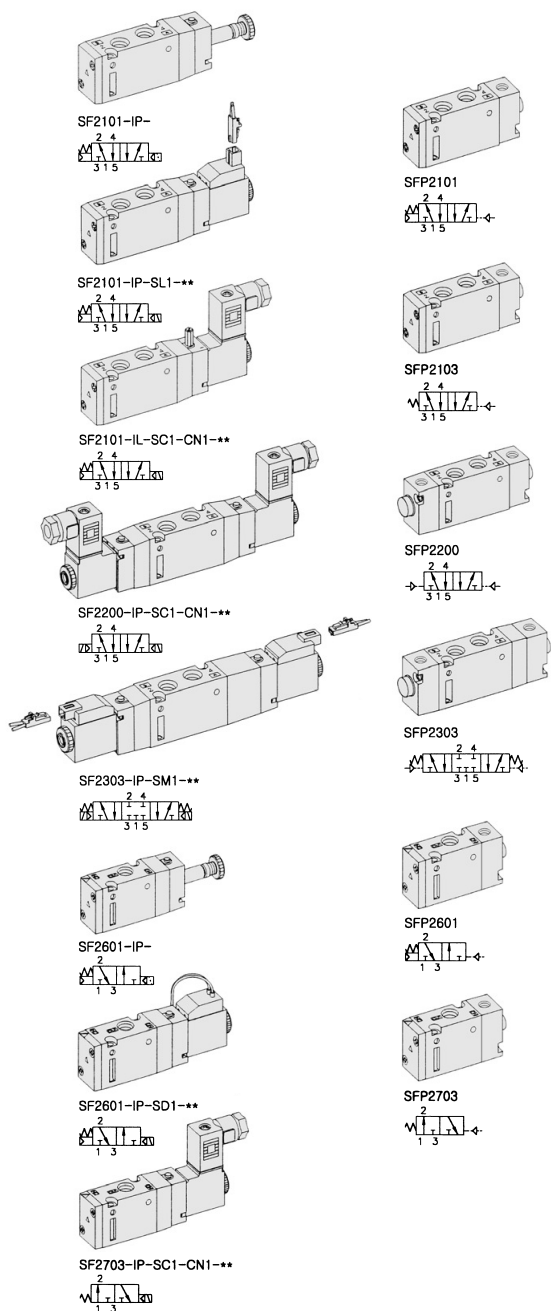

** : Voltage Selection (see page 62)

SPECIFICATION

ITEM	SERIES	SOLENOID, PNEUMATIC	
		FUNCTION	
		5, 3 Port 2 Position	5 Port 3 Position
Fluids		Compressed Air & Inert Gases	
Pressure(bar)		1.5~10.0	2.0~10.0
Eff. Sectional Area(mm ²)-5bar		12.6	9.0
Ambient & Fluid Temp.		5~60°C (41~140°F)	
Response Time(5bar)		25ms or Less	35ms or Less
Max. Working Frequency		5c/sec	3c/sec
Lubrication		Not Required(Use ISO VG32 #)	
Manual Override		Push Button(Standard), Lever Lock(Option)	
Coil Insulation Class		F-Class or Equivalent	
Permissible Voltage Variation		±10% of Rated Voltage	
Off Min. Residual Voltage		AC:20% or Less / DC:10% or Less	
Power Consumption		Holding-AC:3.5VA(60Hz) / DC:2.5W	

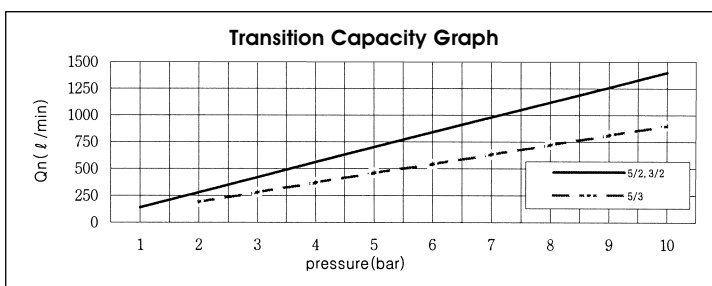

The Material of Parts

- Valve Body : Die-Cast Aluminium
- Spool : Aluminium
- Seals : NBR
- Spring : Stainless
- Cap : Zinc Pressure Die-Cast
- Pilot Parts : Glass Filled Nylon
- Armature : Stainless Steel
- Armature Seals : Viton

Plug Connector With Clip

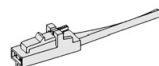

Ordering Code
PG2-06 (L : 600mm)
PG2-10 (L : 1,000mm)

* The specification on each item can be amended without any prenotice to improve a performance.
* The specification on each item can be different from actual specification.

ORDERING NO.

SF2 1 0 1 - I P - SC1 - CN1 - A2

Valve Series	Function	Port Size & Thread	Return Method	Int/Ext. Pilot	Manual Operator	Solenoid Coil Type	Connector Type	Voltage
SF2 : Solenoid Valve	1 5/2 Single	0 G 1/8	0 None	I Internal Pilot	0 None	0 None	0 None	0 None
	2 5/2 Double	1 NPT 1/8	1 Air + Spring		P Push	SC1 3 Pin Connector Coil	CN1 Normal Connector	A2 AC 220V
	3 5/3 Closed Center		2 Air		Non-Locking	SG1 Grommet/Flying Leads	CD1 Connector With LED	A1 AC 110V
SFP2 : Pneumatic Valve	4 5/3 Open Center		3 Spring		L Lever Locking	SD1 Grommet/Flying Leads With LED	CZ1 Connector With LED & Surge Suppressor	A4 AC 24V
	5 5/3 Pressure Center					SL1 90 Degree Plug-in Wire Assembly With LED		D4 DC 24V
	6 3/2 Normally Closed					SM1 180 Degree Plug-in Wire Assembly With LED		D2 DC 12V
	7 3/2 Normally Open							

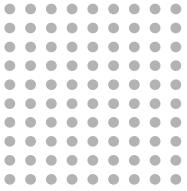

Solenoid & Pilot Actuated Spool Valves

Port Thread 1/8

5Port 2Position Solenoid Valve

Single Solenoid
SF2101-IP-SC1-CN1-***

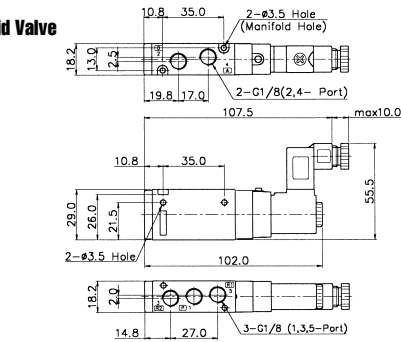

Double Solenoid
SF2200-IP-SC1-CN1-***

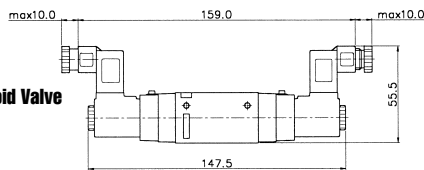

5Port 3-Position Solenoid Valve

Closed Center
SF2303-IP-SM1-***

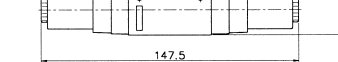
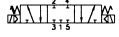

Exhaust Center
SF2403-IP-SM1-***

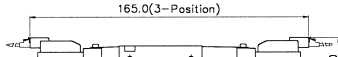
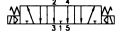

Pressure Center
SF2503-IP-SM1-***

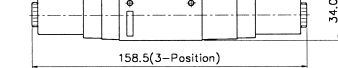
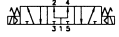

3Port 2Position Solenoid Valve

Normally Closed
SF2601-IP-SD1-***

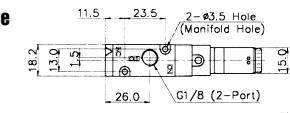

Normally Open
SF2701-IP-SD1-***

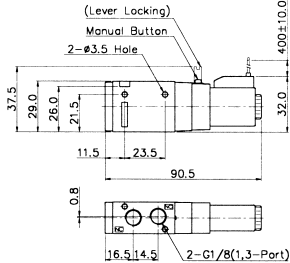

5Port 2Position Pneumatic Valve

Single Pneumatic
SFP2101

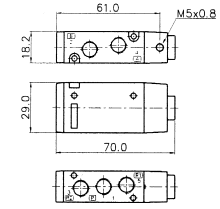

Double Pneumatic
SFP2200

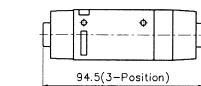
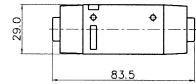

5Port 3-Position Pneumatic Valve

Closed Center
SFP2303

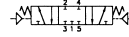

Exhaust Center
SFP2403

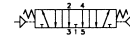

Pressure Center
SFP2503

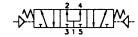

3Port 2Position Pneumatic Valve

Normally Closed
SFP2601

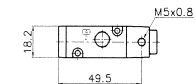

Normally Open
SFP2701

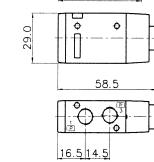

MF2000 MANIFOLD BLOCK

(SF2000 Solenoid & Pneumatic Valve Use)

Manifold Block Ordering Code

MF 2500		-		2	
Series	Manifold Station				
MF2500	5 Way	02	2-Station		
MF2300	3 Way	04	4-Station		
		06	6-Station		
		08	8-Station		
		10	10-Station		

Blanking Plate Ordering Code

MF2500-BLK	Blanking Plate. (Material:SCP1)
	Manifold Gasket. (Material:NBR)
MF2300-BLK	Blanking Plate. (Material:SCP1)
	Manifold Gasket. (Material:NBR)

5-Port Manifold Block

MF2500-4

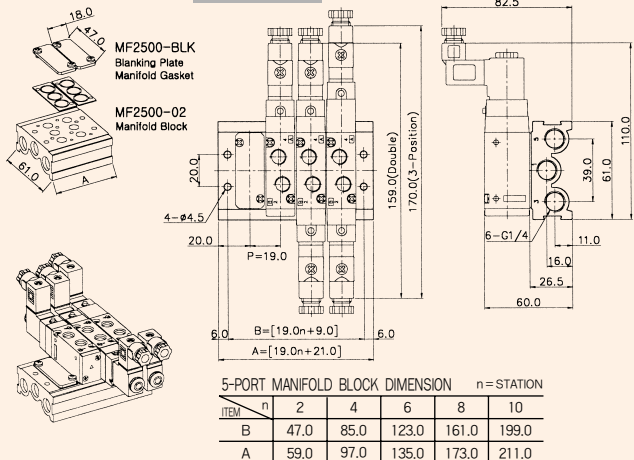

3-Port Manifold Block

MF2300-4

